



# Stainless Series

- Ring Prong Snaps
- S-Spring Snaps
- Ring Spring Snaps
- Jeans Buttons/Rivets
- Grommets/Eyelets



# Stainless Series Ring Prong Snaps

Major market / Usage : Workwears, Uniforms, Medical wears

High durability against rust and stable action force.

Applicable on various fabrics, and on different thickness.

Two types of gripper length available according to usage.





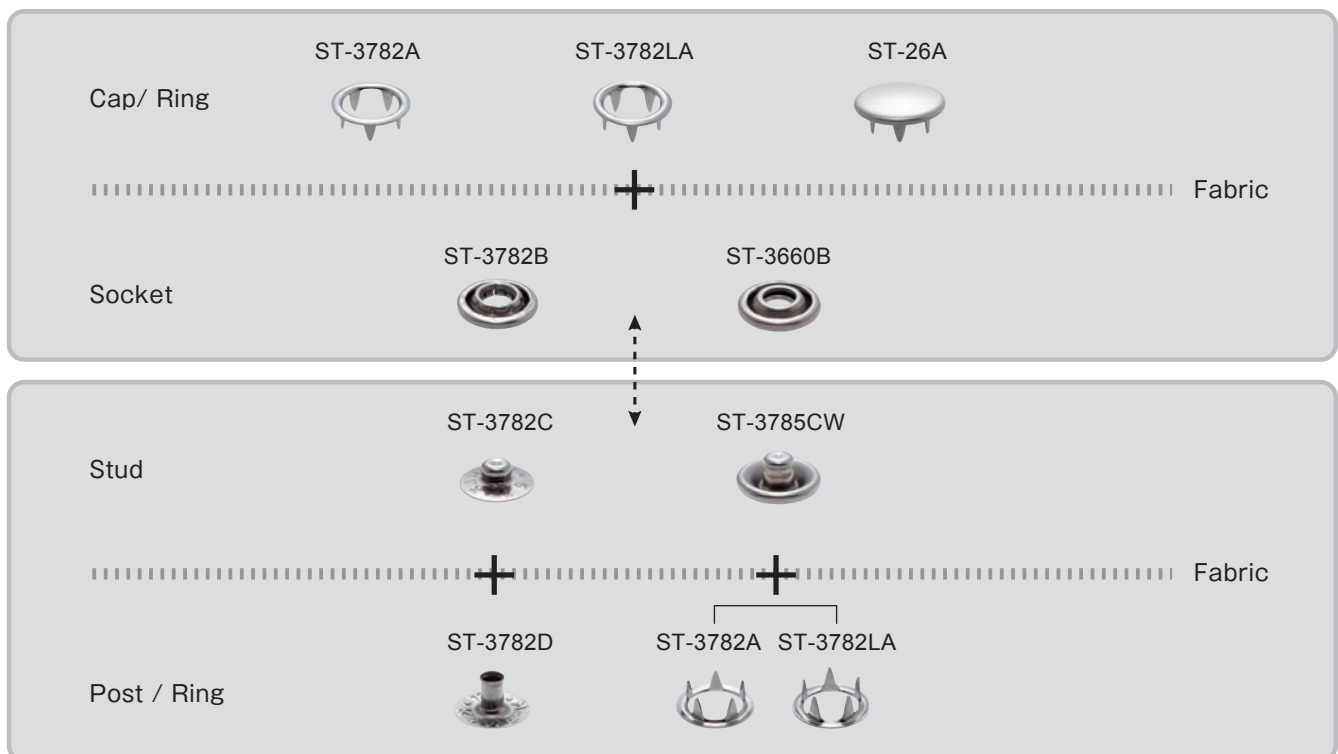





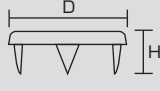

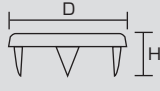

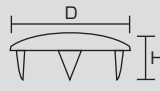

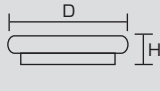
●Combinations

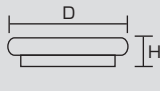

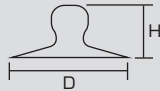
# Stainless Series

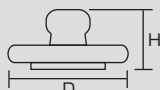
## Ring Prong Snaps

Item / Art #	Parts	Size (mm)	Drawing	Material
 <b>ST-3782 A</b>	Cap/ Ring	D : 10.10 H : 3.60		Stainless Steel
 <b>ST-3782 LA</b>	Cap/ Ring	D : 10.10 H : 4.00		Stainless Steel
 <b>ST-26 A</b>	Cap/ Ring	D : 11.80 H : 4.60		Stainless Steel
 <b>ST-3782 B</b>	Socket	D : 10.90 H : 2.40		Stainless Steel
 <b>ST-3660 B</b>	Socket	D : 10.90 H : 2.30		Stainless Steel
 <b>ST-3782 C</b>	Stud	D : 9.50 H : 3.20		Stainless Steel
 <b>ST-3785 CW</b>	Stud	D : 10.80 H : 4.70		Stainless Steel
 <b>ST-3782 D</b>	Post	D : 9.70 H : 5.20		Stainless Steel

### Remarks

- Non-needle detector free.
- Electric plating not available.
- Color fade and corrosion may be determined on chemical resistance.
- Residual chlorine on fabric may cause corrosion.
- Applicable for various fabric thicknesses with two types of gripper length available.







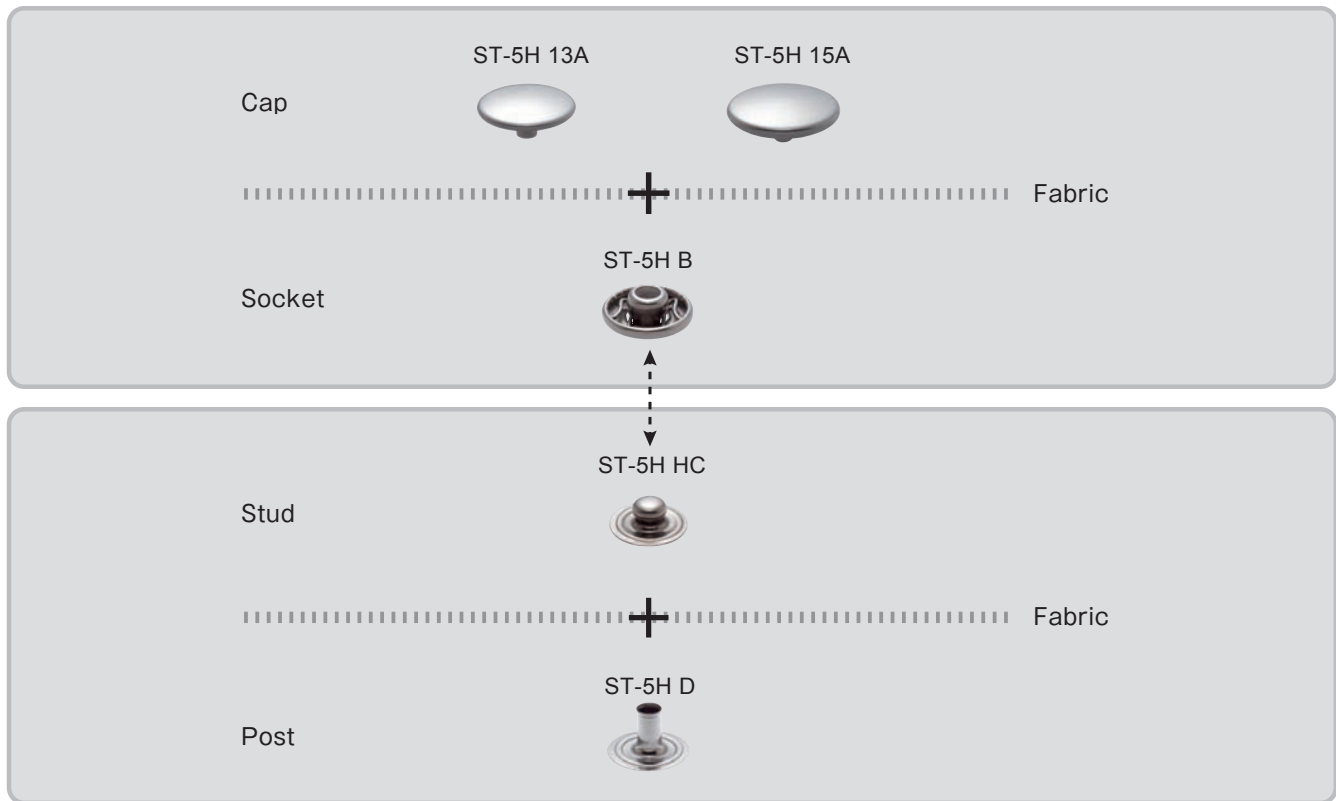

# Stainless Series S-Spring Snaps

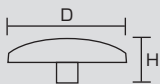
Major market / Usage : Workwears, Uniforms, Medical wears

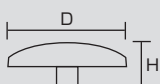
High durability against rust and stable action force.

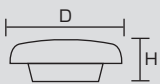
## ●Combinations

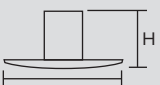

Item / Art #	Parts	Size (mm)	Drawing	Material
 <b>ST-5H 13A</b>	Cap	D : 13.00 H : 5.90		Stainless Steel
 <b>ST-5H 15A</b>	Cap	D : 15.00 H : 5.70		Stainless Steel
 <b>ST-5H B</b>	Socket	D : 12.10 H : 4.20		Stainless Steel
 <b>ST-5H HC</b>	Stud	D : 10.50 H : 4.00		Stainless Steel
 <b>ST-5H D</b>	Post	D : 10.80 H : 6.50		Stainless Steel

### Remarks

- Non-needle detector free.
- Electric plating not available.
- Chemicals may cause color fade and corrosion.
- Residual chlorine on fabric may cause corrosion.

# Stainless Series





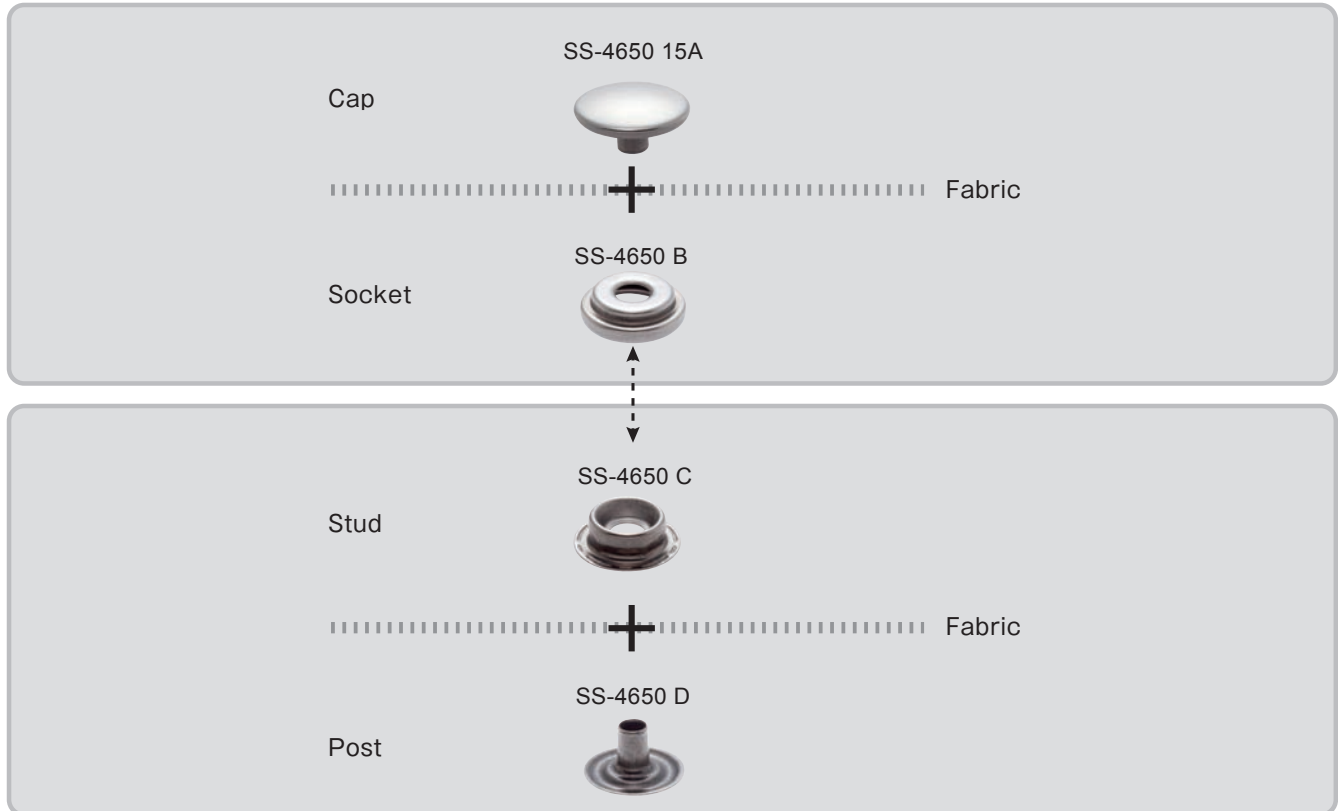

## Ring Spring Snaps

Major market / Usage : Workwears, Uniforms, Medical wears

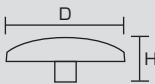
High durability against rust and stable action force.

### ●Combinations

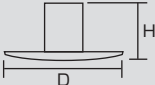

Item / Art #	Parts	Size (mm)	Drawing	Material
 <b>SS-4650 15A</b>	Cap	D : 15.00 H : 7.00		Stainless Steel
 <b>SS-4650 B</b>	Socket	D : 13.80 H : 4.40		Stainless Steel
 <b>SS-4650 C</b>	Stud	D : 14.00 H : 4.40		Stainless Steel
 <b>SS-4650 D</b>	Post	D : 13.20 H : 7.50		Stainless Steel

### Remarks

- Non-needle detector free.
- Electric plating not available.
- Chemicals may cause color fade and corrosion.
- Residual chlorine on fabric may cause corrosion.

# Stainless Series









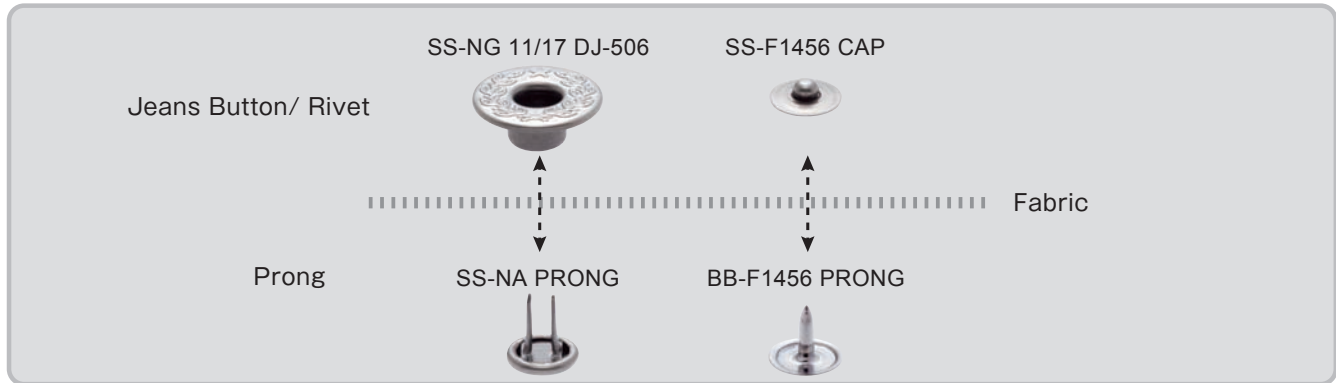

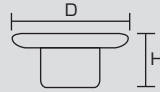
## Jeans Buttons/ Rivets

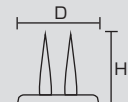
Major market / Usage : Workwears, Uniforms

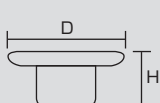
High durability against rust.

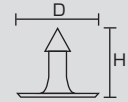
### ●Combinations

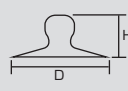

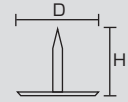
Item / Art #	Parts	Size (mm)	Drawing	Material
 <b>SS-NG 11/17 DJ-506</b>	Jeans Button	D:16.95 H: 6.80		Stainless Steel
 <b>SS-NA PRONG</b>	Prong	D: 9.50 H: 10.00		Stainless Steel
 <b>SS-NR 7/17 DJ-75</b>	Jeans Button	D: 16.90 H 8.40		Stainless Steel
 <b>BB-NR PRONG</b>	Prong	D: 9.10 H: 8.20		Brass
 <b>SS-F1456 CAP</b>	Cap	D: 9.45 H: 2.85		Stainless Steel
 <b>BB-F1456 PRONG</b>	Prong	D: 9.70 H: 8.40		Brass

### Remarks

- Non-needle detector free.
- Electric plating not available.
- Chemicals may cause color fade and corrosion.
- Residual chlorine on fabric may cause corrosion.

## Stainless Series

# Grommets/ Eyelets

Major market / Usage : Car mats, Outdoor products, Marine industries, Fishing, Agricultural industries







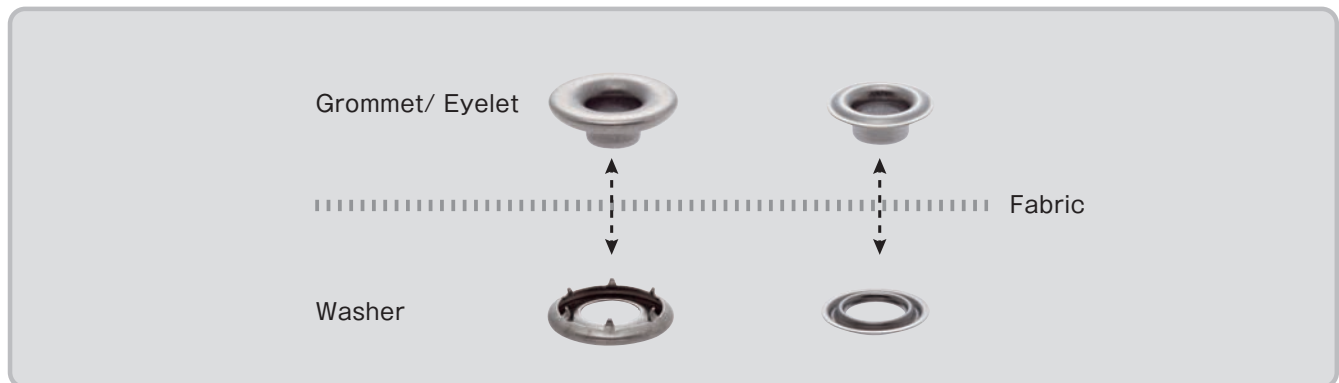



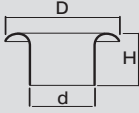



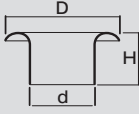

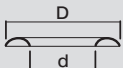

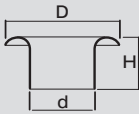

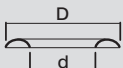

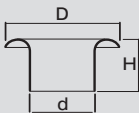
High durability against rust.

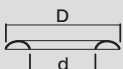

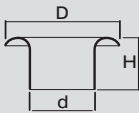
## ● Combinations

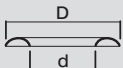

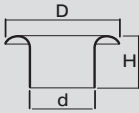
# Stainless Series Grommets









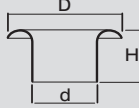

Item / Art #	Parts	Size (mm)	Drawing	Material
 <b>SS0-GRE</b>	Grommet	D : 16.90 d : 6.70 H : 6.20		Stainless Steel
 <b>SS0-GW</b>	Washer	D : 17.10 d : 7.80		Stainless Steel
 <b>SS1-GRE</b>	Grommet	D : 21.00 d : 8.20 H : 8.20		Stainless Steel
 <b>SS1-GW</b>	Washer	D : 21.00 d : 9.10		Stainless Steel
 <b>SS2-GRE</b>	Grommet	D : 22.00 d : 9.45 H : 7.60		Stainless Steel
 <b>SS2-GW</b>	Washer	D : 22.00 d : 10.70		Stainless Steel
 <b>SS3-GRE</b>	Grommet	D : 23.50 d : 11.20 H : 8.00		Stainless Steel
 <b>SS3-GW</b>	Washer	D : 23.70 d : 12.60		Stainless Steel
 <b>SS4-GRE</b>	Grommet	D : 27.00 d : 12.50 H : 9.00		Stainless Steel
 <b>SS4-GW</b>	Washer	D : 26.70 d : 14.00		Stainless Steel
 <b>SS5-GRE</b>	Grommet	D : 31.50 d : 15.90 H : 10.80		Stainless Steel
 <b>SS5-GW</b>	Washer	D : 31.70 d : 17.60		Stainless Steel

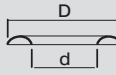
## Remarks

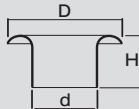
- Non-needle detector free.
- Electric plating not capable.
- Chemicals may cause color fade and corrosion.
- Residual chlorine on fabric may cause corrosion.

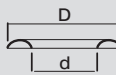

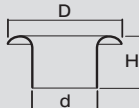
# Stainless Series Eyelets

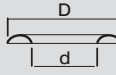
Item / Art #	Parts	Size (mm)	Drawing	Material
 <b>SS-2100E</b>	Eyelet	D : 14.00 d : 6.80 H : 5.00		Stainless Steel
 <b>SS-2100W</b>	Washer	D : 14.60 d : 8.00		Stainless Steel
 <b>SS-2300E</b>	Eyelet	D : 16.00 d : 8.20 H : 6.00		Stainless Steel
 <b>SS-2300W</b>	Washer	D : 16.60 d : 9.60		Stainless Steel
 <b>SS-2500E</b>	Eyelet	D : 19.00 d : 9.20 H : 6.00		Stainless Steel
 <b>SS-2500W</b>	Washer	D : 19.60 d : 10.60		Stainless Steel

#### Remarks

- Non-needle detector free.
- Electric plating not available.
- Chemicals may cause color fade and corrosion.
- Residual chlorine on fabric may cause corrosion.